

NAPOLI

NAPOLI/1200/1040

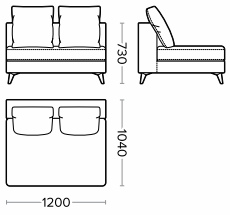

NAPOLI/1400/1040

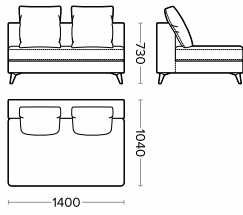

NAPOLI/1600/1040

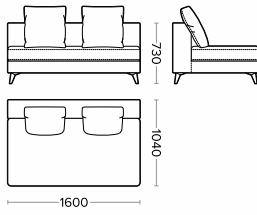

NAPOLI/1800/1040

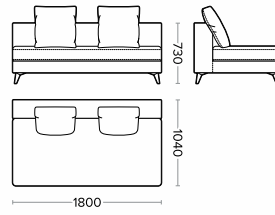

NAPOLI/2000/1040

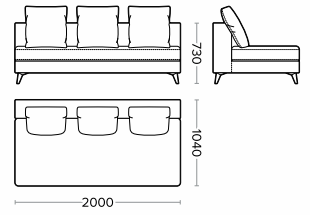

NAPOLI/RA/1350/1040

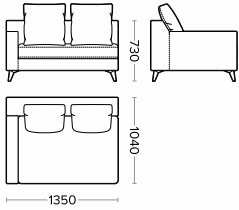

NAPOLI/LA/1350/1040

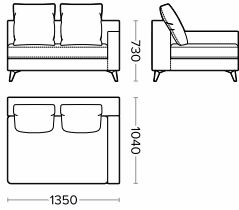

NAPOLI/RA/1550/1040

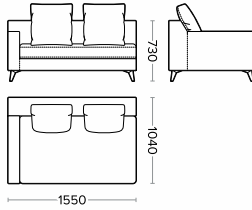

NAPOLI/LA/1550/1040

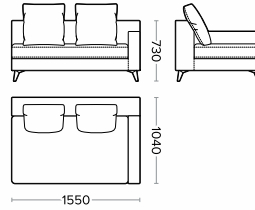

NAPOLI/RA/1750/1040

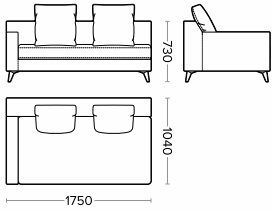

NAPOLI/LA/1750/1040

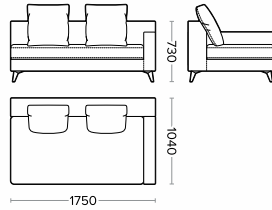

NAPOLI/RA/1950/1040

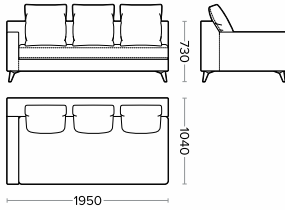

NAPOLI/LA/1950/1040

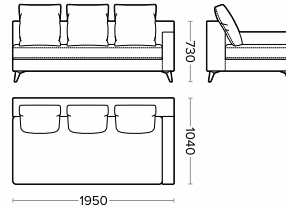

NAPOLI/RA/2150/1040

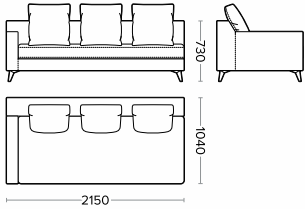

NAPOLI/LA/2150/1040

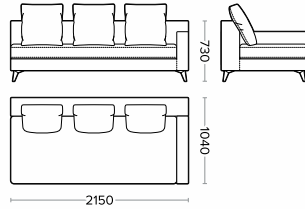

NAPOLI/C/BR/1420/1040

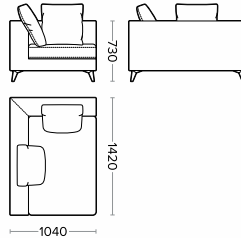

NAPOLI/C/BL/1420/1040

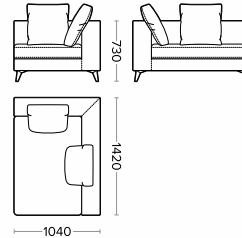

NAPOLI/C/BR/1620/1040

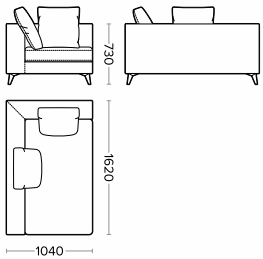

NAPOLI/C/BL/1620/1040

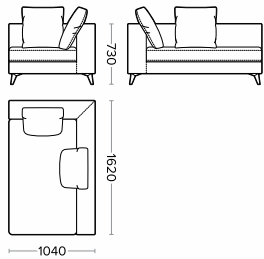

NAPOLI/C/BR/1820/1040

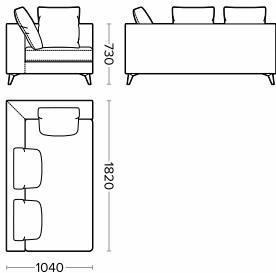

NAPOLI/C/BL/1820/1040

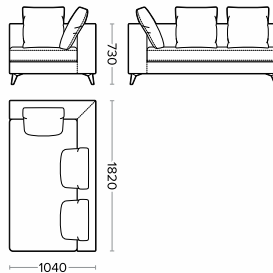

NAPOLI/C/BR/2020/1040

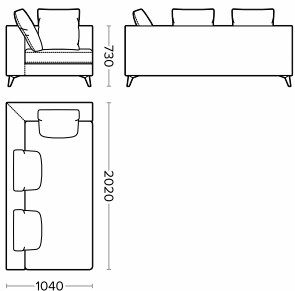

NAPOLI/C/BL/2020/1040

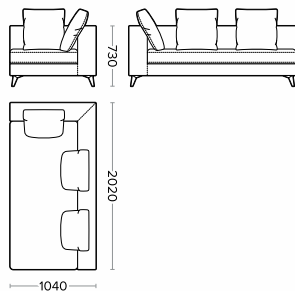

NAPOLI/C/BR/2220/1040

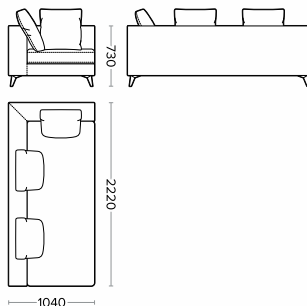

NAPOLI/C/BL/2220/1040

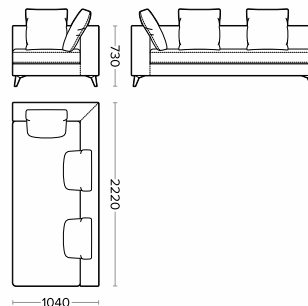

NAPOLI/C/BSR/1420/1040

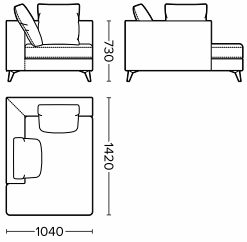

NAPOLI/C/BSL/1420/1040

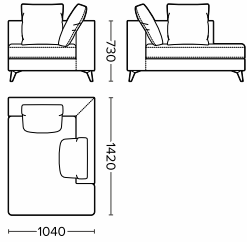

NAPOLI/C/BSR/1620/1040

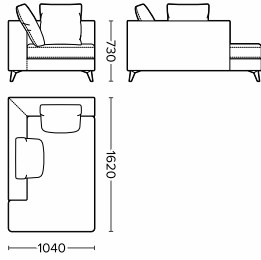

NAPOLI/C/BSL/1620/1040

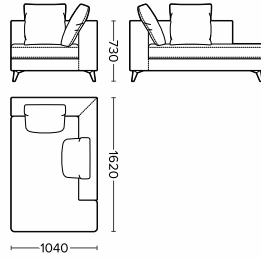

NAPOLI/C/BSR/1820/1040

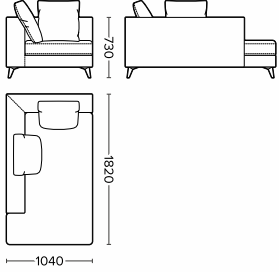

NAPOLI/C/BSL/1820/1040

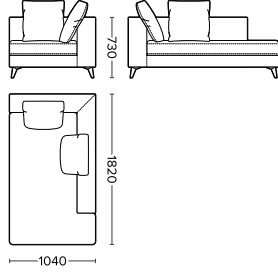

NAPOLI/C/BSR/2020/1040

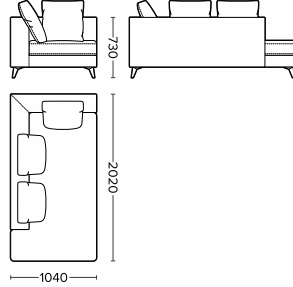

NAPOLI/C/BSL/2020/1040

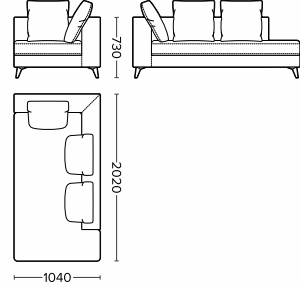

NAPOLI/C/BSR/2220/1040

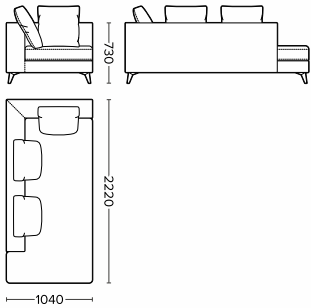

NAPOLI/C/BSL/2220/1040

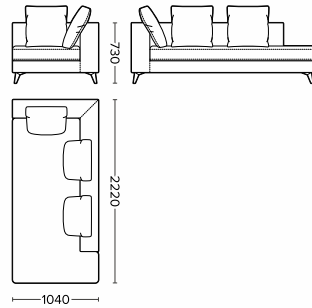

NAPOLI/C/1040/1040

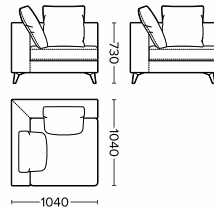

NAPOLI/2A/2100/1040

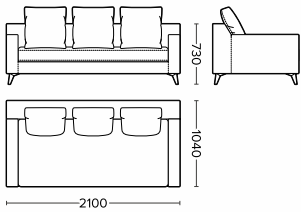

NAPOLI/2A/2300/1040

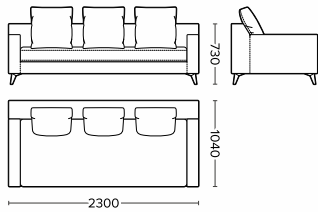

P1

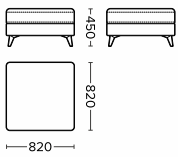

P2

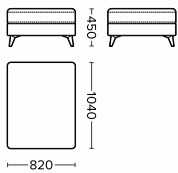

P3

